

## Sewy

### Übersicht theoretische BÜGELEINTEILUNG Staby - BÜGEL

	A	B	C	D	E	F	G	H
<b>B1 208</b>	70	65						
<b>B2 216</b>	75	70	65					
<b>B3 224</b>	80	75	70	65				
<b>B4 232</b>	85	80	75	70	65			
<b>B5 240</b>	90	85	80	75	70	65		
<b>B6 256</b>	95	90	85	80	75	70	65	
<b>B7 272</b>	100	95	90	85	80	75	70	65
<b>B8 288</b>	105	100	95	90	85	80	75	70
<b>B9 304</b>	110	105	100	95	90	85	80	75
<b>B10 320</b>	115	110	105	100	95	90	85	80
<b>B11 330</b>	120	115	110	105	100	95	90	85
<b>B12 340</b>	125	120	115	110	105	100	95	90
<b>B13 350</b>	130	125	120	115	110	105	100	95
<b>B14 370</b>	135	130	125	120	115	110	105	100

### Übersicht „Schalencup“ BÜGELEINTEILUNG Staby - BÜGEL

	AA	A	B	C	D	E	F	G	H
<b>Staby 168</b> (174)	70	65							
<b>Staby 192</b> (183)	75	70	65						
<b>Staby 200</b> (201)	80	75	70	65					
<b>Staby 216</b>	85	80	75	70	65				
<b>Staby 224</b>	90	85	80	75	70	65			
<b>Staby 232</b>	95	90	85	80	75	70	65		
<b>Staby 248</b>	100	95	90	85	80	75	70	65	
<b>Staby 256</b>	105	100	95	90	85	80	75	70	65
<b>Staby 272</b>		105	100	95	90	85	80	75	70
<b>Staby 288</b>			105	100	95	90	85	80	75

Bei den kleineren Größen kann man den Staby BÜGEL durch einen flachen Flexy ersetzen (Größenangaben in Klammern)

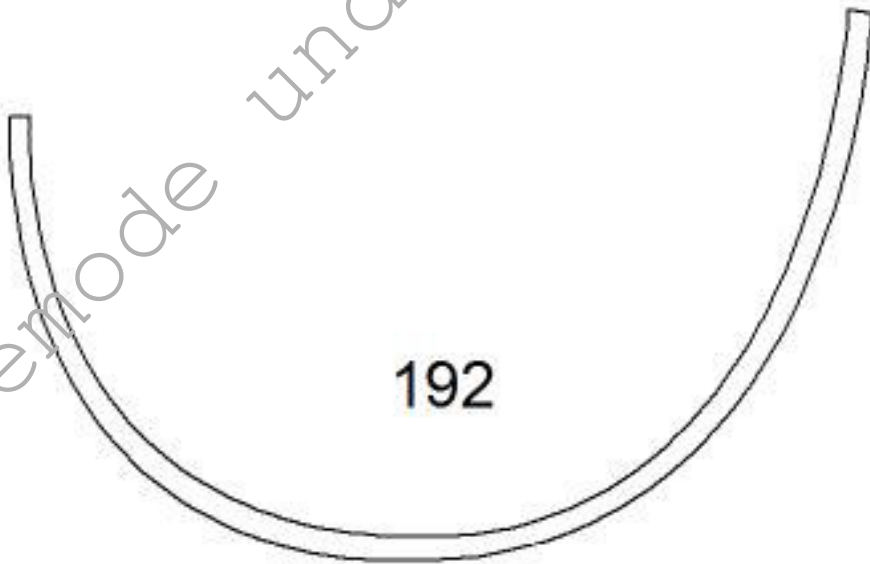
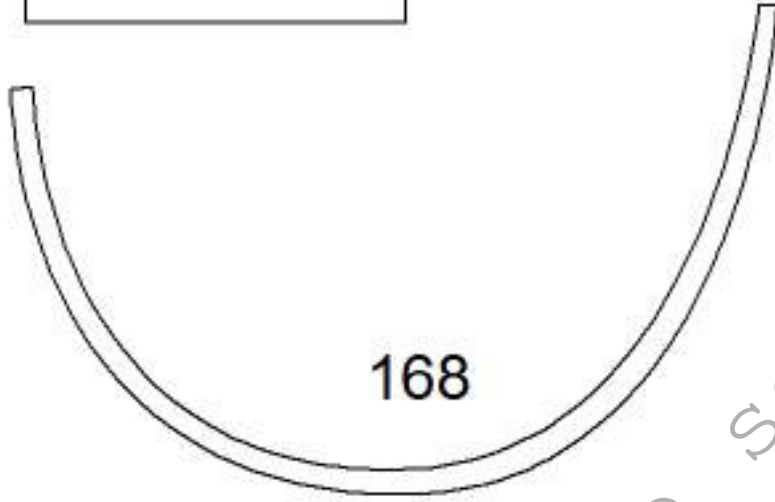
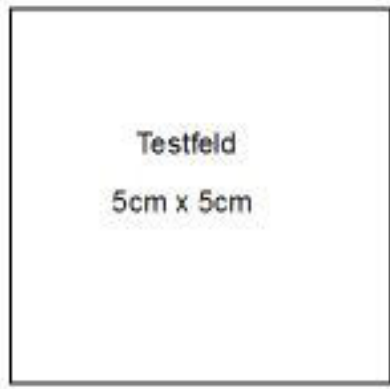

ewy bademode und wäsche selber machen

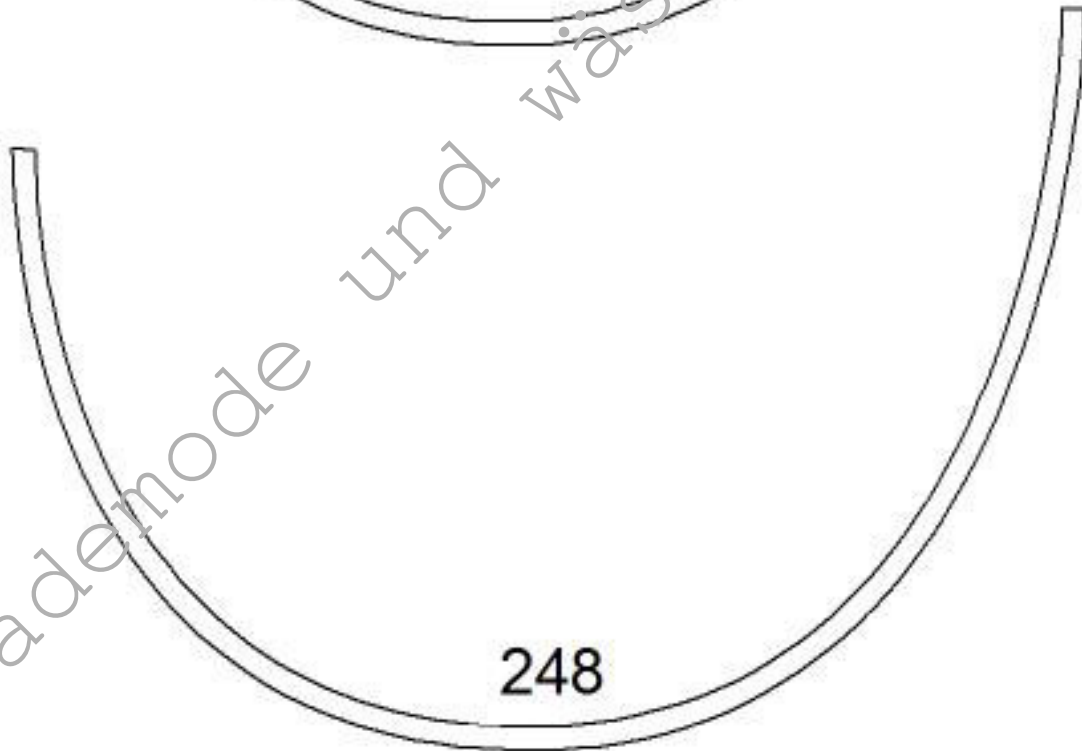
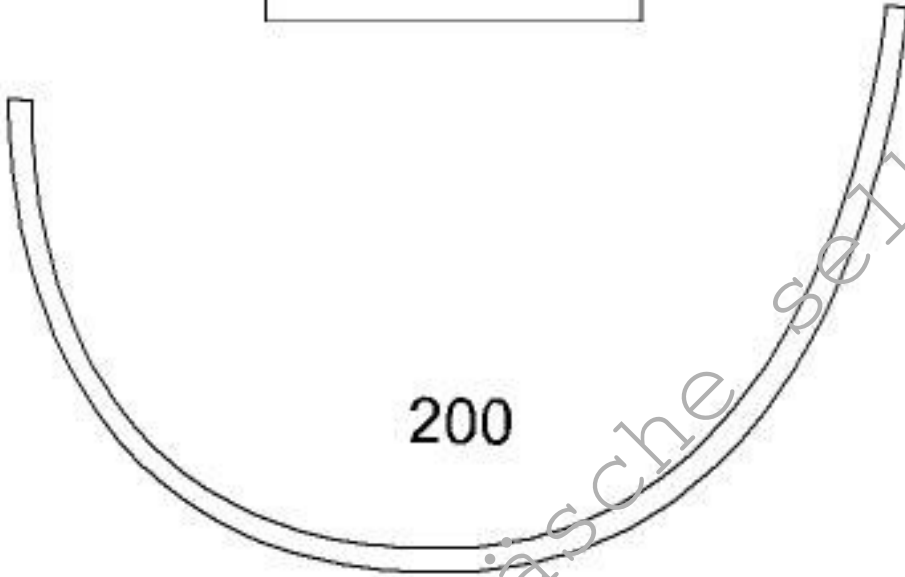
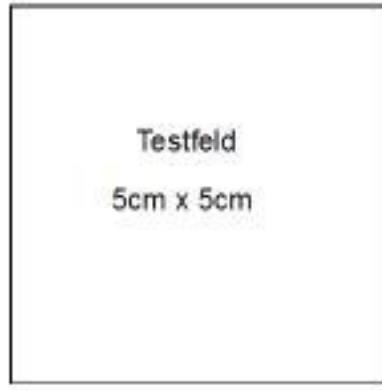

ewy bademode und wasche selber mach

ewy bademode und wäsche selber machen

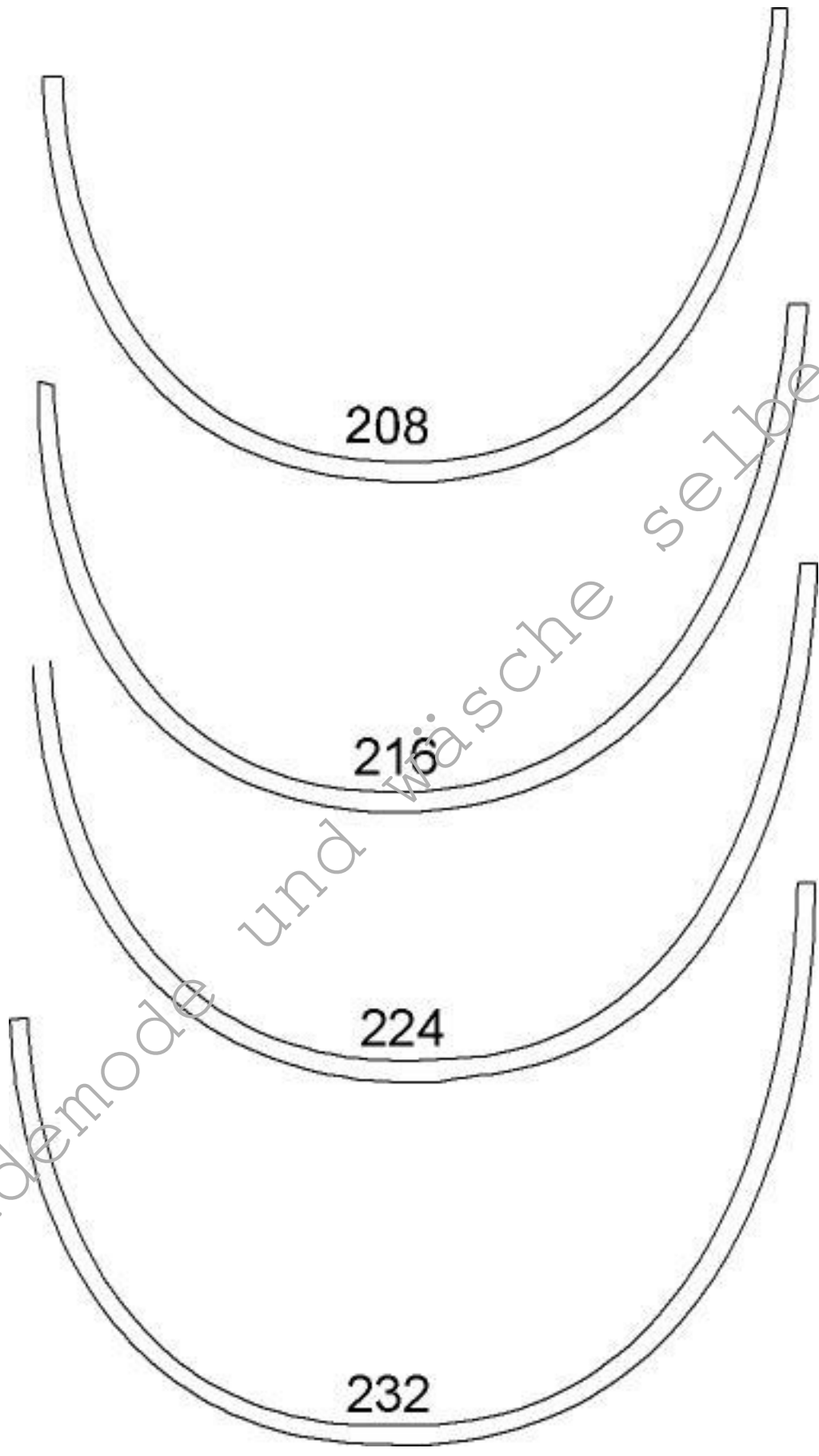

208

216

224

232

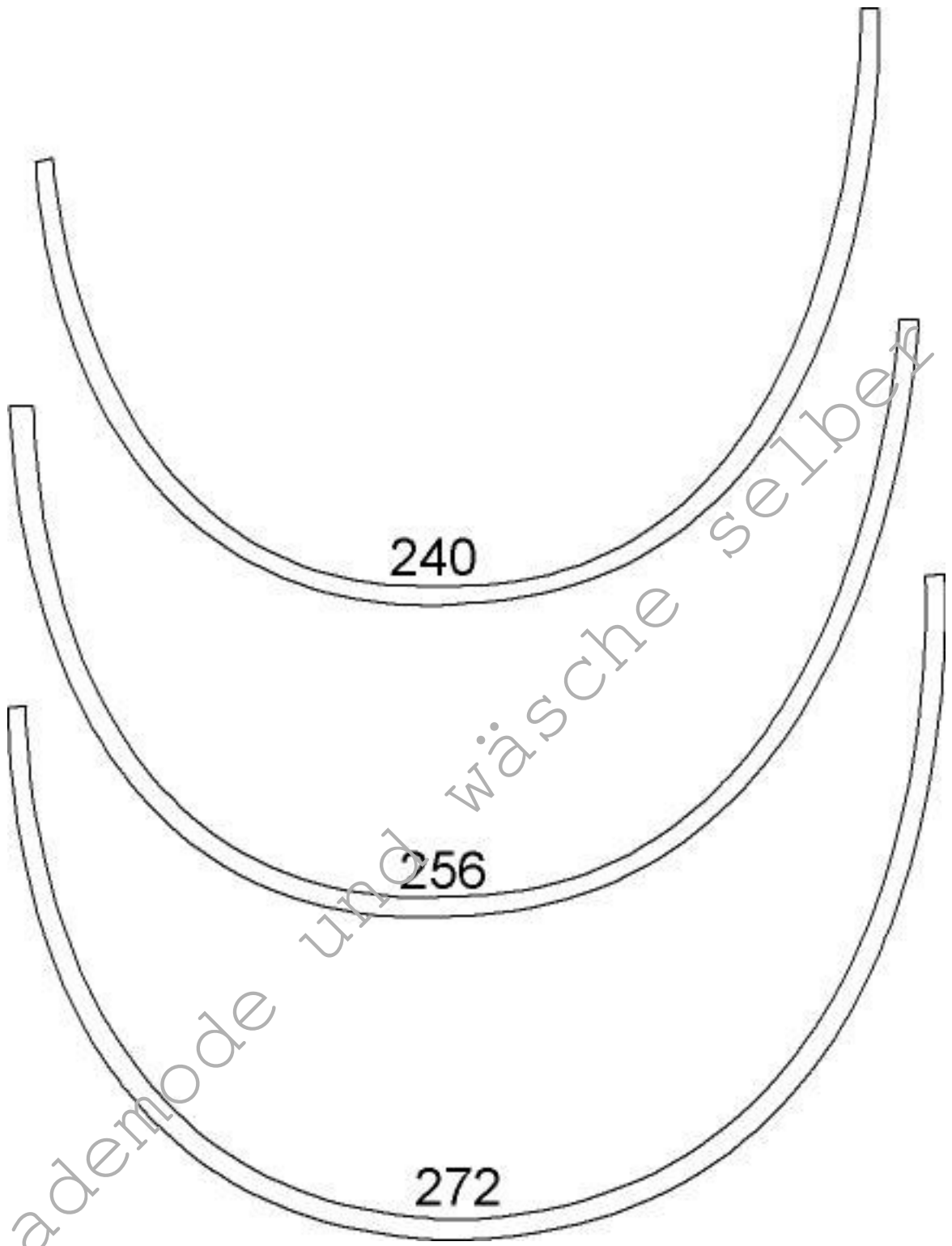

ewy bademode und wäsche selber machen

ewy bademode und wäsche selber machen

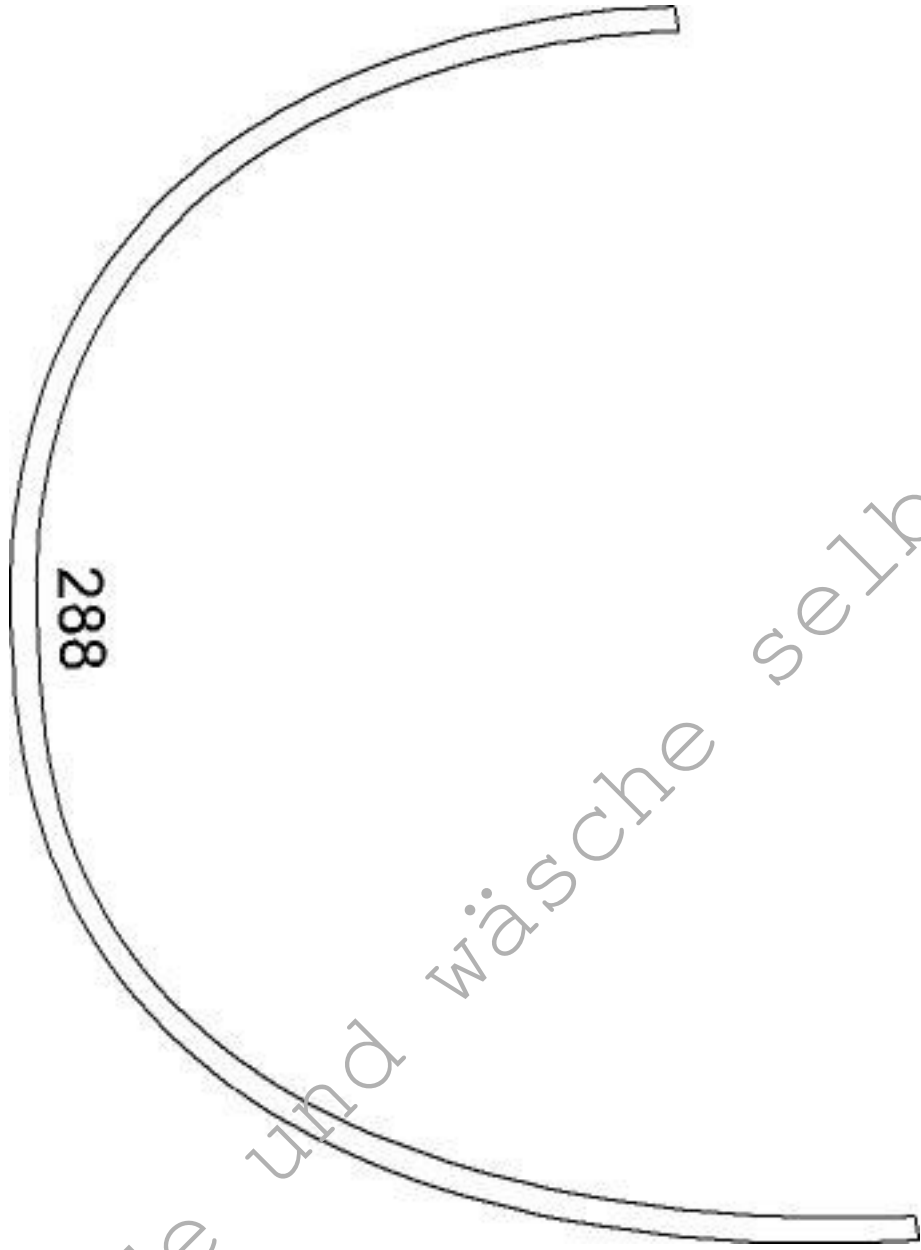

ewy bademode und wäsche selber machen

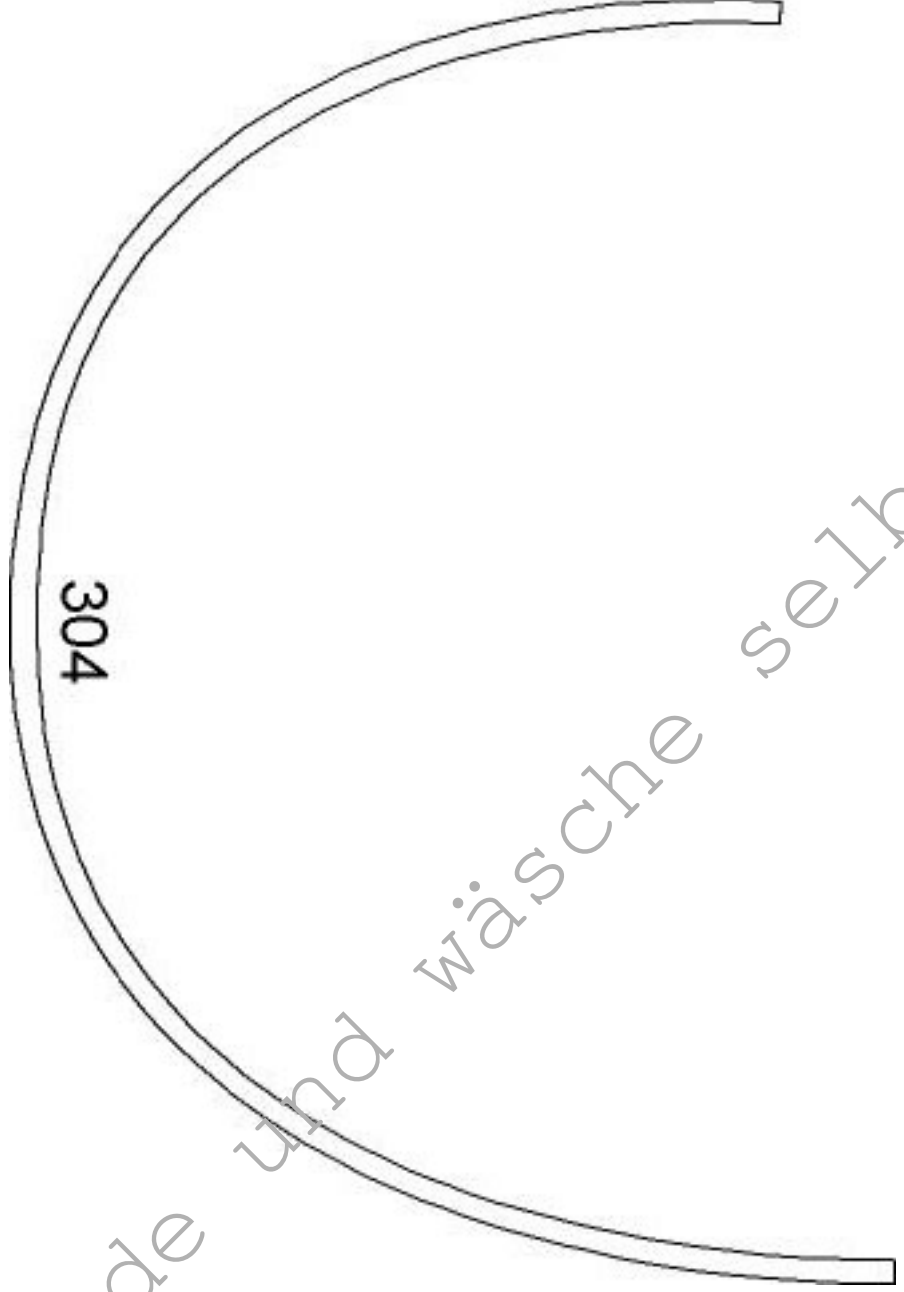

ewy bademode und wäsche selber machen

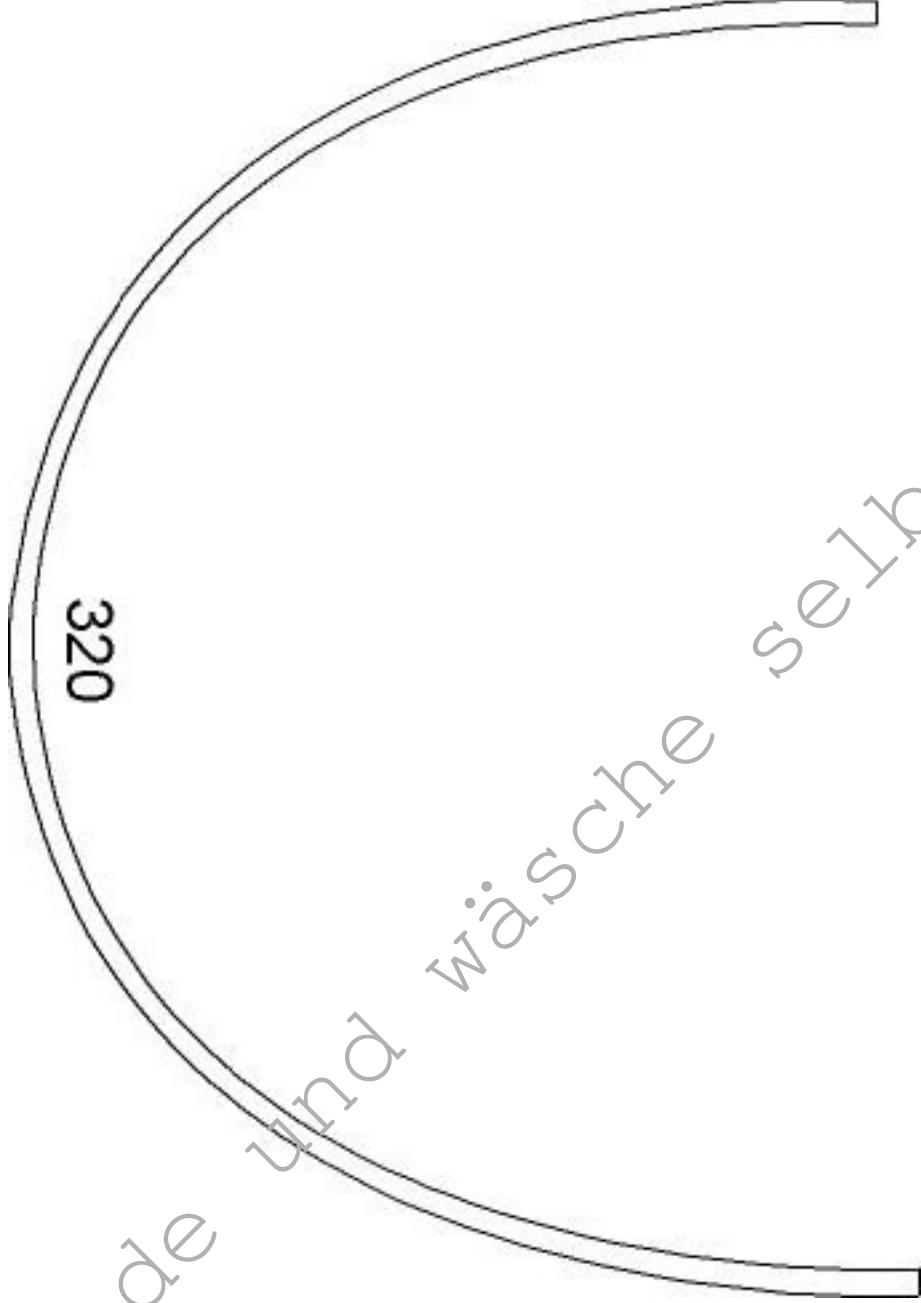



ewy bademode und wäsche selber machen

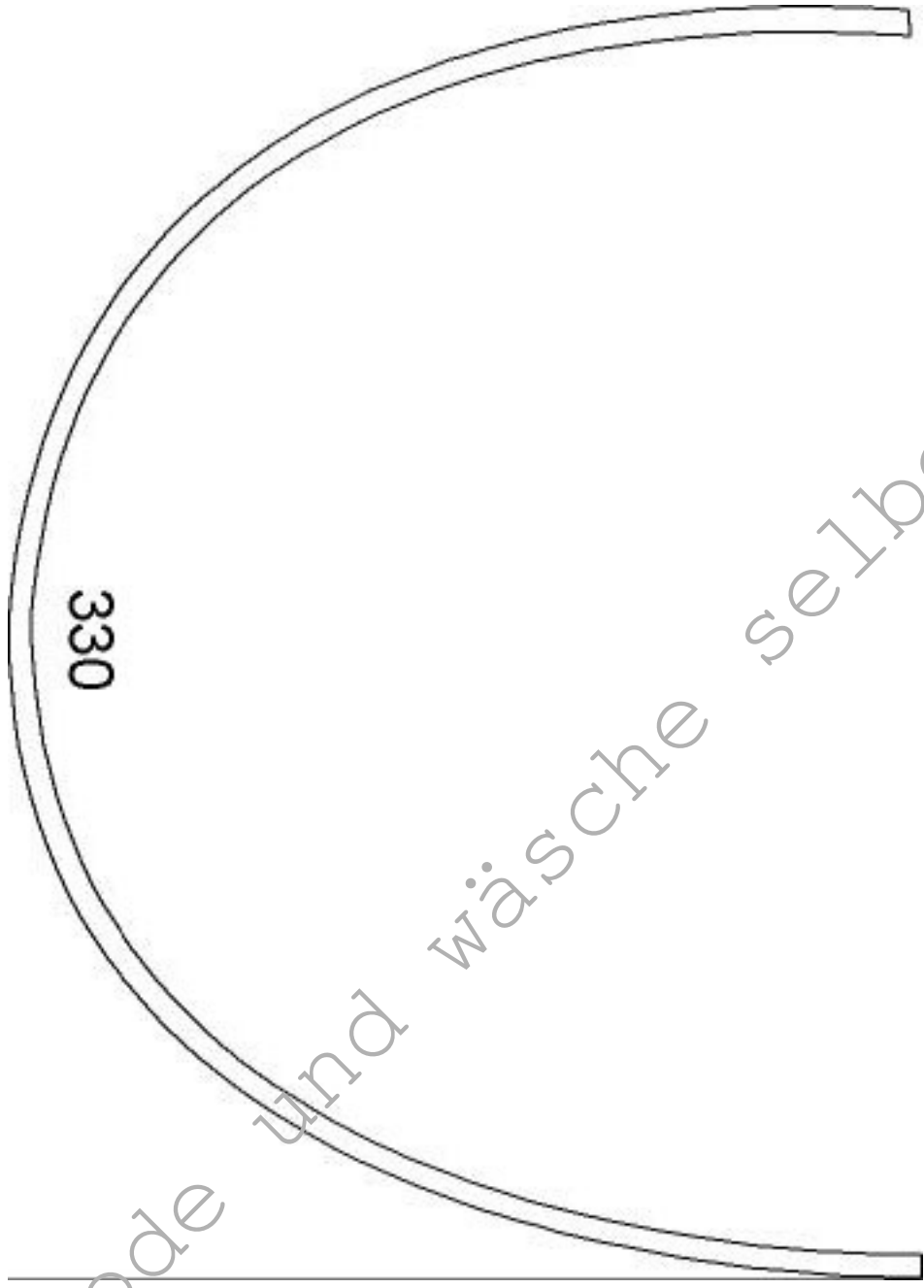

330

ewy bademode und wäsche selber machen

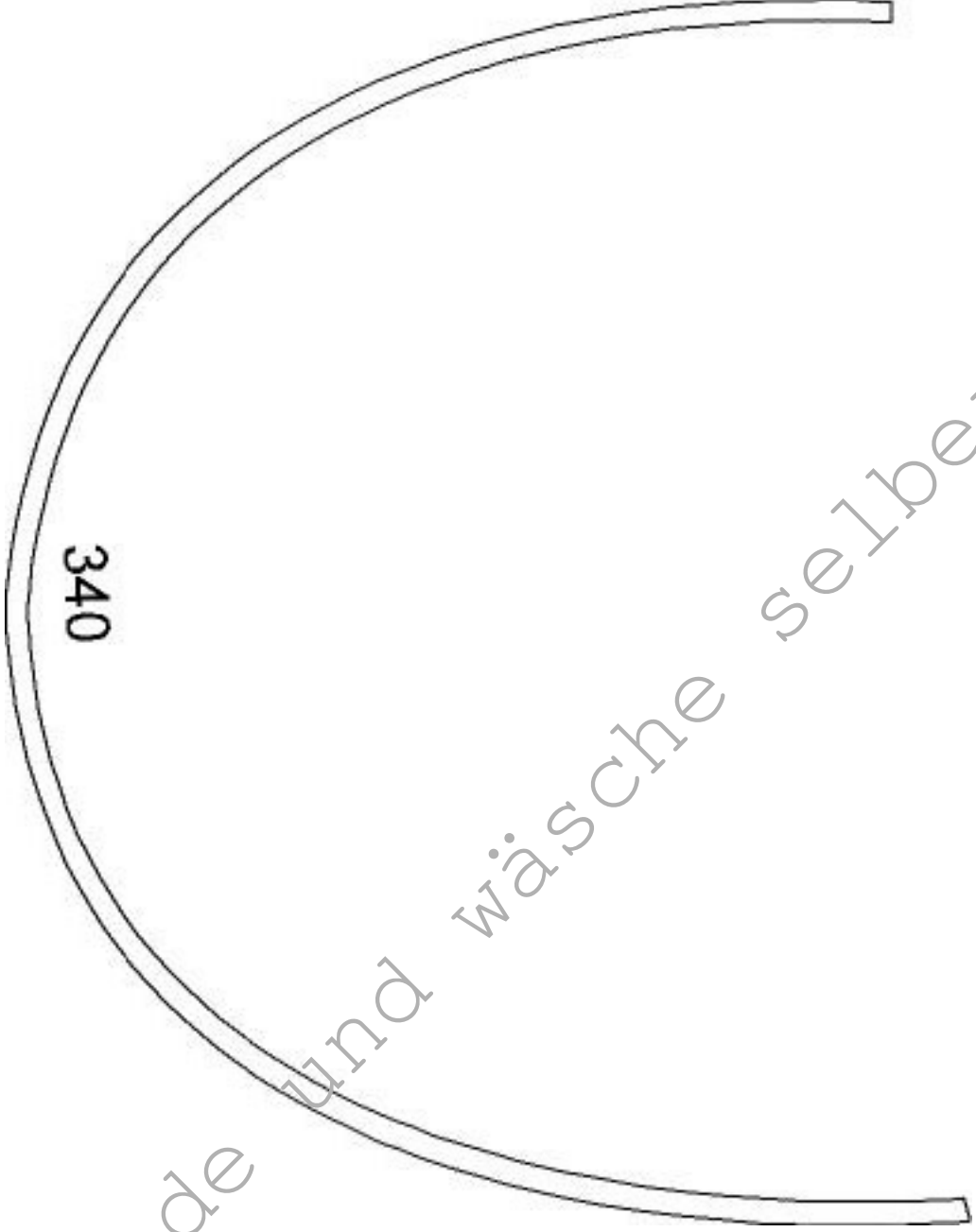

ewy bademode und wäsche selber machen

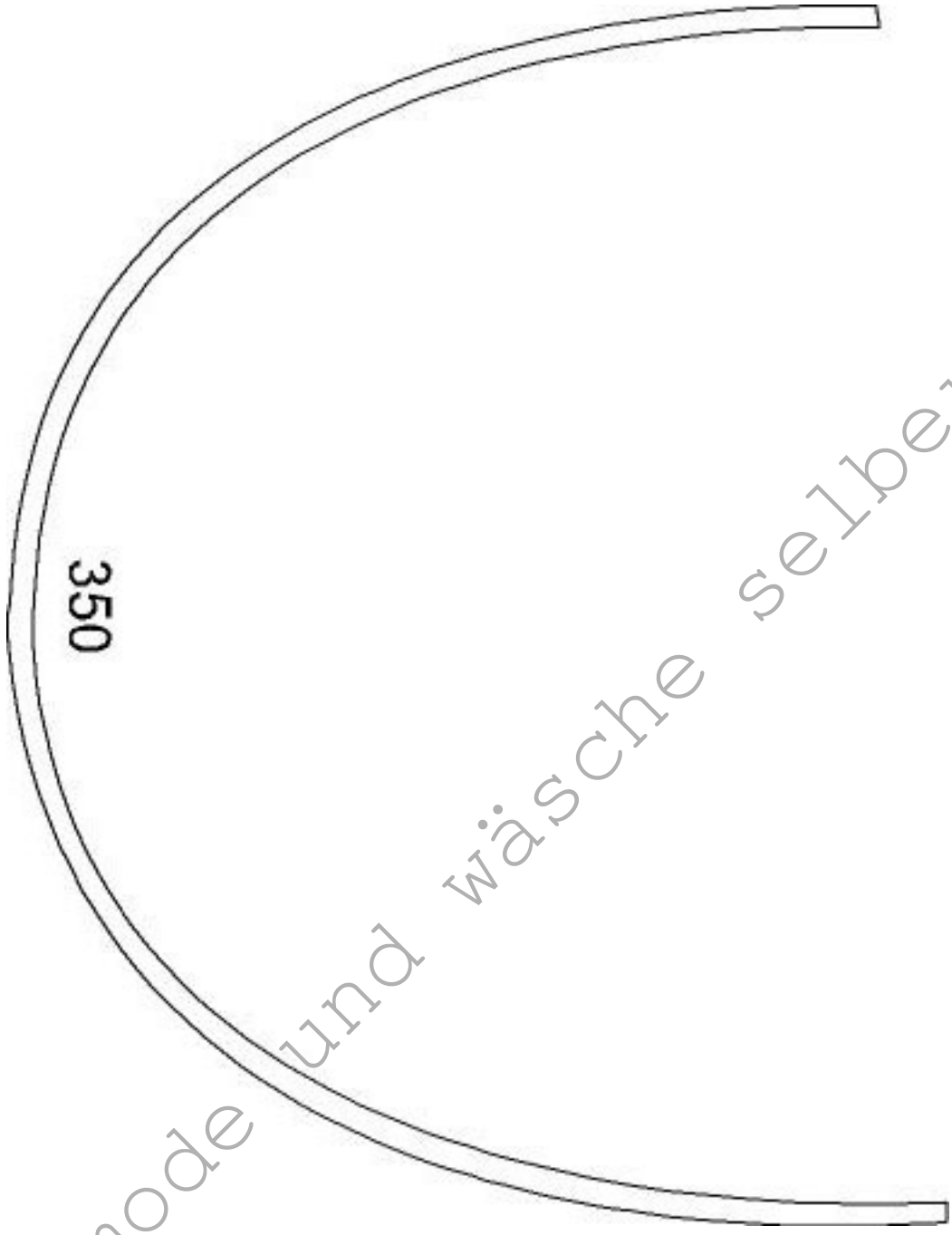

ewy bademode und wäsche selber machen

